



# HIGH VISIBILITY HANDBOOK



**SOLUTIONS, SUPPORT AND OUR COMPLETE HI-VIS LINE-UP**

# BE SEEN. FEEL HEARD.

**WITH A RESPONSIVE, FULL-SERVICE HI-VIS PROGRAM THAT WORKS FOR YOU.**

Any knucklehead can slap some silver tape on neon mesh and call it a day. But the truth is, “worker safety” and “lowest bidder” go together as well as orange juice and toothpaste. Or nuts and gum. Or reasonable debate and Thanksgiving with Uncle Larry the conspiracy theorist (turns out proving the world ISN'T ruled by an elite group of reptiles secretly led by Justin Bieber is harder than you think).

Anyway, on the flip side of all that is a responsive, full-service program that works for you. An extension of our decades' long obsession with helping Make the Workplace a Betterplace™. Whatever it takes. Sure, that means the most Tenacious Work Gear® on the planet. But it also means a deep, fine-print level understanding of standards & risk, matched with an eagerness to help solve your unique end-to-end challenges—from spec to supply chain.

So whether it's considering your crew's compliance down to the last square inch of fabric (hey, it's a fine line between nerdery and tenacity) or partnering to create just the right solution to reflect the realities of your worksite, we're here—and we've got your be-seen back.

**CLICK TO VIEW FULL GLOWEAR LINE >>>**

## **WHY ERGODYNE Pg. 4-5**

### **YOUR PARTNER IN SHINE SINCE 1983**

Activate a hi-vis partner who knows, cares and dares to put your success over all else.

## **INNOVATION BY COLLABORATION Pg. 6-7**

### **EVERY CHALLENGE HAS A BRIGHT SIDE**

Go beyond “being seen” with hi-vis gear built in collaboration with folks like you.

## **HI-VIS SELECTION**

### **WE'VE GOT YOUR BE-SEEN BACK**

Any job. Any budget. Whatever your hi-vis needs, we've got you covered.

<b>ESSENTIAL SHIRTS</b>	<b>Pgs. 8-9</b>
<b>PERFORMANCE SHIRTS</b>	<b>Pgs. 10-11</b>
<b>WOMEN'S APPAREL</b>	<b>Pgs. 12-13</b>
<b>SWEATSHIRTS</b>	<b>Pgs. 14-15</b>
<b>CLASS 2</b>	<b>Pgs. 16-19</b>
<b>CLASS 3</b>	<b>Pgs. 20</b>
<b>FR VESTS</b>	<b>Pgs. 22-23</b>
<b>PUBLIC SAFETY VESTS</b>	<b>Pgs. 24-25</b>
<b>CLASS 1 &amp; NON CERT</b>	<b>Pgs. 26-27</b>
<b>JACKETS</b>	<b>Pgs. 30-31</b>
<b>RAINWEAR</b>	<b>Pgs. 32</b>
<b>PANTS, BIBS &amp; GAITERS</b>	<b>Pgs. 33</b>
<b>HEADWEAR</b>	<b>Pgs. 34-35</b>
<b>ACCESSORIES</b>	<b>Pgs. 36</b>
<b>HARD HAT ACCESSORIES</b>	<b>Pgs. 37</b>

## **CUSTOM LOGO PROGRAM Pg. 21**

### **Mmmm...SMELLS LIKE TEAM SPIRIT**

Submit your design or use one of our ready-made templates

## **HI-VIS STANDARDS Pg. 28-29**

### **EASY AS 1-2-3 (E-O-R-P)**

# YOUR PARTNER IN SHINE

Did you know all Class 2, Type R garments require 201 square inches of reflective? Or that there isn't an orange flame-resistant fabric in existence that's ANSI/ISEA 107 approved?

Gold star if you did. But if not, we're here to translate the tough stuff to make sure every crew you serve is always compliantly up to code with solutions that meet the demands that matter most. Yours.

“From helping maintain compliance and working closely with us to develop the best possible solutions to fit our very specific needs. Ergodyne's hi-vis program is second to none.”

- Leading Airline Safety Director

# WHY US? BECAUSE WORKER SAFETY IS NOT A COMMODITY

In a world where dayglow grifters and bottom-dollar bidders would lead you to believe it's all the same, we're out to prove that saving a few dimes on the front end isn't worth the inevitable bite in the back end.



## INNOVATION

Why stop at “being seen” when you can turn this staple of personal protective equipment into personal *productivity* equipment? Through far-out performance fabrics and above-and-beyond design features, we're helping create crews of shiny happy people with mindfully crafted, high-quality gear.

## COLLABORATION

From hi-vis development and testing to risk assessment and identifying compliance gaps in your existing hi-vis program, everything we do is driven by a commitment to deeply knowing what you and your crew are up against day after day.

## EDUCATION

If you find the subtleties of hi-vis standards easy to miss, no worries. You're not the only one. In fact, we've helped some of the biggest organizations in the world get up to code with a deep-seated knowledge built over 20+ years on the ANSI/ISEA 107 Hi-Vis Product Group Committee (the group that helps inform, shape and revise the hi-vis standard).



every challenge has a

# BRIGHT SIDE



## EXTREME TEMPERATURES

From workplace inferno to Ice Station Zebra, you've always got the right look-at-me layer to help you hold the line when Mother Nature loses her mind.



## DOUBLE TROUBLE

Sparks? Flames? Tools with commitment issues? Handle two kinds of trouble at once (and cover your regulatory heinie) with hi-vis that doesn't stop at being seen.



## THE PREDICTABLY UNPREDICTABLE

Some jobs run hot. Some jobs run cold. Some hit every extreme before lunch. Thankfully your impossibly versatile, shapeshifting jack[et] of all temps is along for the ride.



## TWO WAYS TO STAND OUT

Essential or Performance Series—one gets the job done, the other goes the extra mile. Neither will let you down.



## SHINE BRIGHT, TREAD LIGHT

Eco-friendly solutions made with high-performance post-consumer materials—so you can go greener without giving up a single stitch of safety.



## FIT FOR THE JOB

Our Women's Hi-Vis Collection is designed to work hard, look the part and (are you ready for this??) actually fit. "Shrink it and pink it"? We say shove it (respectfully).

GLOWEAR® HI-VIS:

# ESSENTIAL SHIRTS

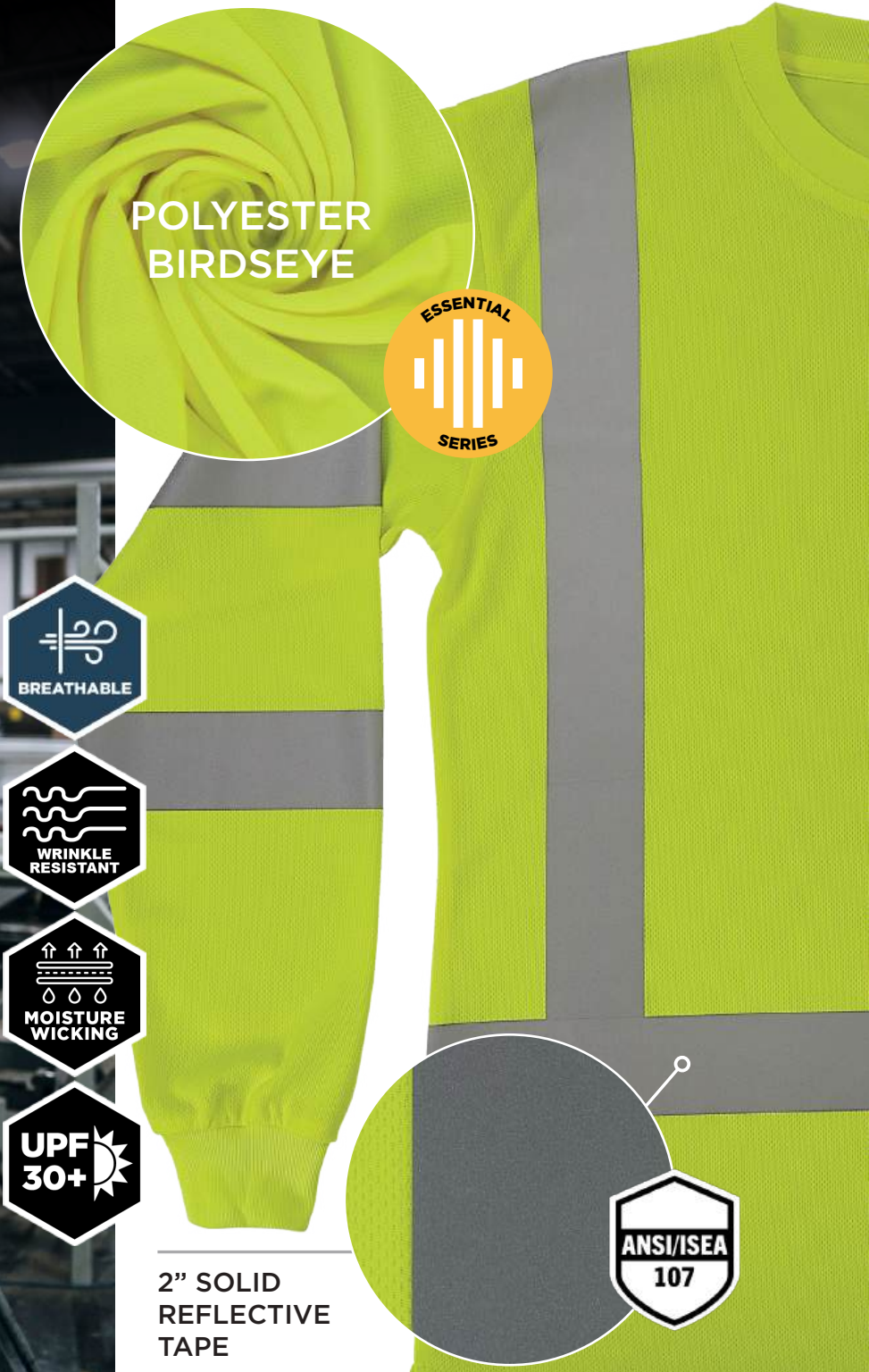

POLYESTER BIRDSEYE



2" SOLID REFLECTIVE TAPE

## ESSENTIAL SERIES GETS THE JOB DONE

Keep it simple, Shiny. No frills, no fuss. Just soft, breathable comfort and budget-friendly dependability you'll keep reaching for without thinking twice.

8367

6688



**8284**  
LONG SLEEVE T-SHIRT, ESSENTIAL, TYPE R, CLASS 2



**8367**  
T-SHIRT, ESSENTIAL, TYPE R, CLASS 3



**8369BK**  
LONG SLEEVE T-SHIRT, ESSENTIAL, TYPE R, CLASS 3, BLACK BOTTOM



**8274**  
T-SHIRT, ESSENTIAL, TYPE R, CLASS 2



**8374**  
LONG SLEEVE T-SHIRT, ESSENTIAL, TYPE R, CLASS 2



**8368**  
LONG SLEEVE T-SHIRT, ESSENTIAL, TYPE R, CLASS 3



**8286BK**  
T-SHIRT, ESSENTIAL, TYPE R, CLASS 2, BLACK BOTTOM



**8092**  
T-SHIRT, ESSENTIAL, NON-CERTIFIED



**8093**  
LONG SLEEVE T-SHIRT, ESSENTIAL, NON-CERTIFIED



**8282**  
T-SHIRT, ESSENTIAL, TYPE R, CLASS 2



**8295**  
POLO T-SHIRT, TYPE R, CLASS 2



**8289-ECO**  
T-SHIRT, RECYCLED, TYPE R, CLASS 2



**6688**  
LONG SLEEVE SUN SHIRT, COOLING, TYPE R, CLASS 2

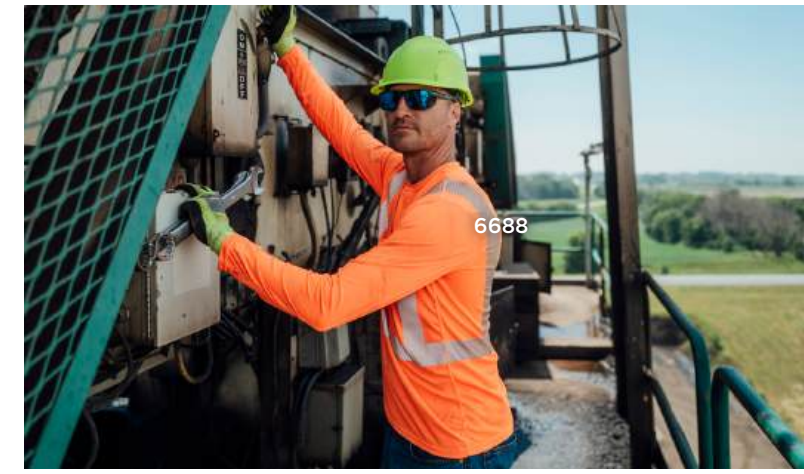

GLOWEAR® HI-VIS:

# PERFORMANCE SHIRTS

POLYESTER DOBBY



2" SEGMENTED REFLECTIVE TAPE



## PERFORMANCE SERIES GOES THE EXTRA MILE

When the day demands more (and when doesn't it?), up the ante with tougher materials, smarter treatments and all-day endurance that earns its keep and then some.

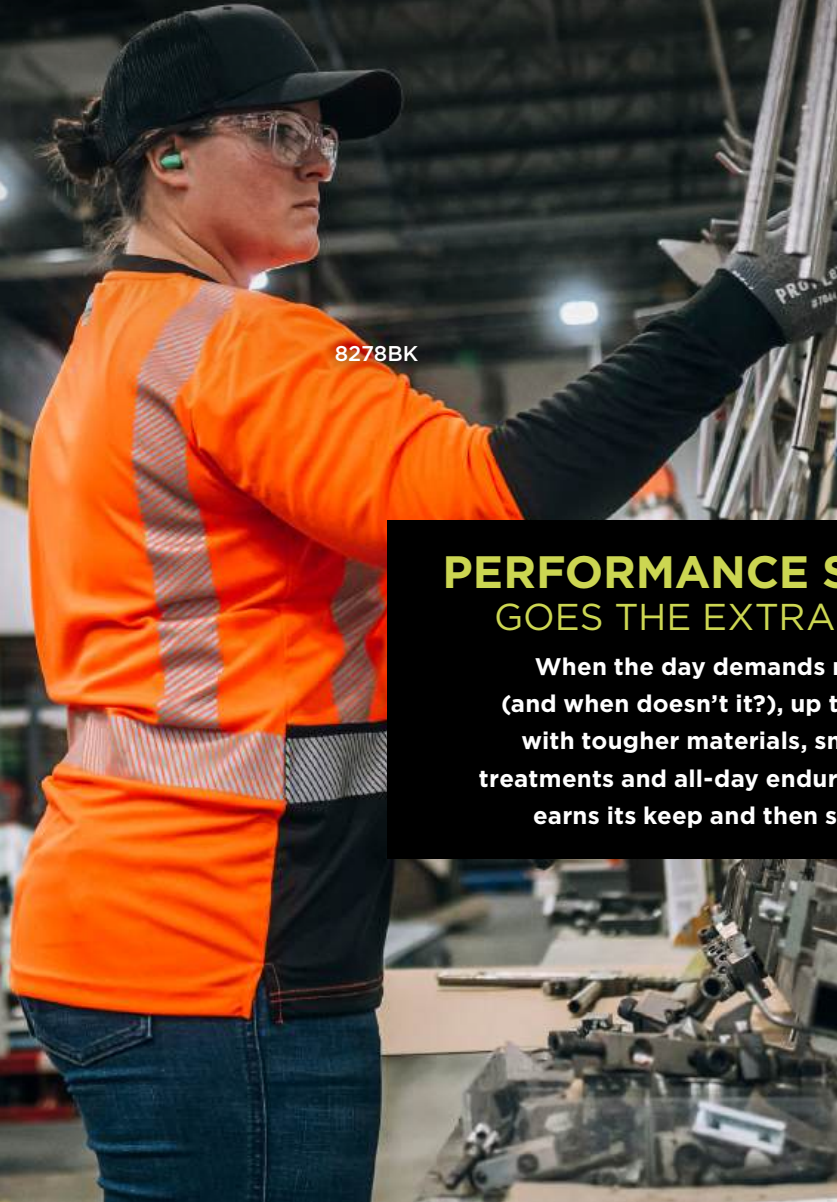

8278BK



**8294BK**  
T-SHIRT, PERFORMANCE, TYPE R, CLASS 2, BLACK BOTTOM



**8292**  
T-SHIRT, PERFORMANCE, TYPE R, CLASS 2



**8370**  
LONG SLEEVE T-SHIRT, PERFORMANCE, TYPE R, CLASS 3



**8371BK**  
LONG SLEEVE T-SHIRT, PERFORMANCE, TYPE R, CLASS 3, BLACK BOTTOM



**8276BK**  
T-SHIRT, PERFORMANCE, TYPE R, CLASS 2



**8278BK**  
LONG SLEEVE T-SHIRT, PERFORMANCE, TYPE R, CLASS 2



**8387**  
LONG SLEEVE T-SHIRT, PERFORMANCE, TYPE R, CLASS 3



**8280BK**  
T-SHIRT, TYPE R, CLASS 2, BLACK BOTTOM



**8281BK**  
LONG SLEEVE T-SHIRT, TYPE R, CLASS 2, BLACK BOTTOM



8294BK



STRONGER MATERIAL

SMARTER TREATMENTS

ALL-DAY COMFORT

# WOMEN'S HI-VIS APPAREL

workwear designed to own the day.

Show up, handle your biz, make it look easy. All that in a vest that fits like a windsail, no less. Impressive. But that's been your M.O. long before anyone bothered with gear that could keep up like this collection—hi-vis vests, shirts and sweatshirts that look right, move right and stay out of the way so you can own the day.

Just like always.  
[ergo.zone/womensworkwear](http://ergo.zone/womensworkwear)



NARROW SHOULDERS

8374

CONTOURED WAIST

SIDE SLITS

LONGER TAIL



## PERFORMANCE SERIES



**8274**  
 Essential Hi-Vis T-Shirt - Type R, Class 2



**8374**  
 Essential Hi-Vis Long Sleeve T-Shirt - Type R, Class 3



**8210HLW-S**  
 Hi-Vis Vest, Hook & Loop - Type R, Class 2



**8276BK**  
 Performance Hi-Vis T-Shirt - Type R, Class 2, Black Bottom



**8278BK**  
 Performance Hi-Vis Long Sleeve T-Shirt - Type R, Class 2, Black Bottom



**8210ZW-S**  
 Hi-Vis Vest, Zipper - Type R, Class 2



**8304W**  
 Performance Hi-Vis Hooded Sweatshirt - Type R, Class 3



**8387**  
 Performance Hi-Vis Long Sleeve T-Shirt - Type R, Class 3



**8215BAW-S**  
 Hi-Vis Breakaway Vest, Hook & Loop - Type R, Class 2



**8305W**  
 Performance Hi-Vis Zip-Up Sweatshirt - Type R, Class 3



8387



**8247ZW-S**  
 Hi-Vis Surveyor Vest, Zipper - Type R, Class 2

GLOWEAR® HI-VIS:

# SWEATSHIRTS

Tenacious Work Gear gone soft? Never. But our hi-vis hoodies are made to coddle workers in conspicuous comfort with soft polyester fleece that's equal parts cozy and uncompromising. Cuddly like a kitten. Tougher than a junkyard dog. Always tenacious.



**8311BK**  
HOODED SWEATSHIRT, ESSENTIAL,  
TYPE R, CLASS 3, BLACK BOTTOM



**8312BK**  
HOODED ZIP-UP SWEATSHIRT,  
ESSENTIAL, TYPE R, CLASS 3,  
BLACK BOTTOM



2" SOLID REFLECTIVE TAPE

8311BK



STRONGER MATERIAL

SMARTER TREATMENTS

ALL-DAY COMFORT



2" SEGMENTED REFLECTIVE TAPE

8304W



**8304W**  
HOODED SWEATSHIRT, PERFORMANCE,  
TYPE R, CLASS 3



**8305W**  
HOODED ZIP-UP SWEATSHIRT,  
PERFORMANCE, TYPE R, CLASS 3



**8317BK**  
HOODED SWEATSHIRT,  
PERFORMANCE, TYPE R, CLASS 3,  
BLACK BOTTOM



**8318BK**  
HOODED ZIP-UP SWEATSHIRT,  
PERFORMANCE, TYPE R, CLASS 3,  
BLACK BOTTOM

GLOWEAR® HI-VIS:

# CLASS 2 SAFETY VESTS

When you're burning the midnight oil on interstate highways and byways, spelunking below the crust of the earth ferreting out the next great mother lode or fixing your burgh's energy grid during a blackout, you need to make sure you're visible. Highly visible. To avoid drama in the darkness, outfit yourself in our ANSI/ISEA 107-compliant GloWear safety vest line and become a beacon unto others.



OLD "NOT SO" HI-VIS



NEW HI-VIS

## BADGE OF HONOR? THINK AGAIN

**YOUR POINT OF PRIDE IS MISSING THE POINT**

Too cool to wear a bright, shiny (reflective) vest on the job? Afraid you'll look too much like a wide-eyed, coffee-fetching rookie? Time for a reality check, you ol' grizzled vet you. It seems your point of pride is missing the point. If you're not seen, you're at risk. With experience comes wisdom, act like it and stay visible.



**8205HL-ECO**  
RECYCLED VEST, MESH, TYPE R, CLASS 2, HOOP & LOOP, NO POCKETS



**8210HLW-S/8210ZW-S**  
VEST, MESH, TYPE R, CLASS 2, HOOP & LOOP OR ZIPPER



**8205HL/8205Z**  
VEST, MESH, TYPE R, CLASS 2, HOOP & LOOP OR ZIPPER, NO POCKETS



**8216BA**  
VEST, BREAKAWAY, MESH, TYPE R, CLASS 2, ID BADGE HOLDER



**8217BA**  
VEST, BREAKAWAY, MESH, TYPE R, CLASS 2, HOOK & LOOP



**8220HL/8220Z**  
VEST, MESH, TYPE R, CLASS 2, HOOK & LOOP OR ZIPPER, STANDARD



**8231TV**  
TOOL TETHERING SAFETY VEST, TYPE R, CLASS 2, ZIPPER, DUAL CERTIFIED



**8215BAW-S**  
VEST, BREAKAWAY, MESH, TYPE R, CLASS 2, HOOK & LOOP



**8225HL/8225Z**  
VEST, SOLID, TYPE R, CLASS 2, HOOK & LOOP OR ZIPPER, STANDARD



**8229Z**  
VEST, TWO-TONE, TYPE R, CLASS 2, ZIPPER, ECONOMY



**8230Z**  
VEST, TWO-TONE, MESH, TYPE R, CLASS 2, ZIPPER



**8235ZX**  
VEST, TWO-TONE, X-BACK, TYPE R, CLASS 2, ZIPPER

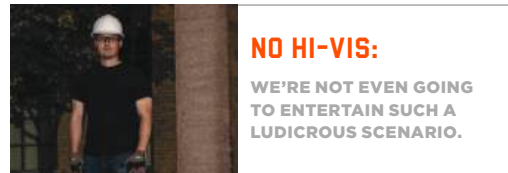

**NO HI-VIS:**  
WE'RE NOT EVEN GOING TO ENTERTAIN SUCH A LUDICROUS SCENARIO.



**OLD HI-VIS:**  
BETTER THAN NOTHING, BUT NOTHING IS A PRETTY LOW BAR. LIKE, THE LOWEST.

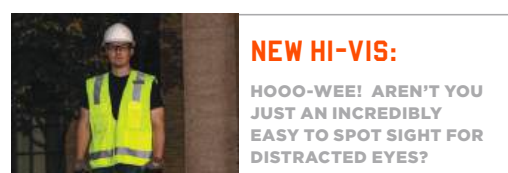

**NEW HI-VIS:**  
HOOO-WEE! AREN'T YOU JUST AN INCREDIBLY EASY TO SPOT SIGHT FOR DISTRACTED EYES?



**8247ZW-S**  
VEST, SURVEYORS, TYPE R, CLASS 2, ZIPPER



**8248Z**  
VEST, TWO-TONE SURVEYORS, TYPE R, CLASS 2, ZIPPER



**8250Z/8250ZH**  
VEST, SURVEYORS, TYPE R, CLASS 2, ZIPPER / COMBINED PERFORMANCE TAPE



**8253HDZ**  
VEST, HEAVY-DUTY MESH SURVEYORS, TYPE R, CLASS 2, ZIPPER



**8256Z**  
VEST, SELF-EXTINGUISHING, TYPE R, CLASS 2, ZIPPER

GLOWEAR® HI-VIS:

# CLASS 2 SAFETY VESTS



8254HDZ

**ZIPPERED REAR POCKET**  
DOCUMENT/TABLET



LANYARD GROMMET HOLES & DUAL RADIO MIC TABS



**8254HDZ**

VEST, HEAVY-DUTY SURVEYORS, TYPE R, CLASS 2, ZIPPER



- WHEN WET, POLYMER-EMBEDDED MID-LAYER PROVIDES HOURS OF COOLING
- SOAK IN WATER FOR 2-5 MINUTES TO ACTIVATE
- RE-WET TO REUSE



**6668**

CHILL-ITS® COOLING VEST, TYPE R, CLASS 2, ZIPPER

- POLYMER-EMBEDDED COOLING TECHNOLOGY
- ANSI/ISEA 107, TYPE R CLASS 2 COMPLIANT WITH 2" REFLECTIVE TAPE FOR LOW-LIGHT VISIBILITY
- LIGHTWEIGHT & BREATHABLE MESH BOTTOM



6668



**8210HL/8210Z/8210HL-S**  
VEST, MESH, TYPE R, CLASS 2, HOOK & LOOP OR ZIPPER, ECONOMY, DUAL SIZE / SINGLE SIZE



**8215BA/8215BA-S**  
VEST, BREAKAWAY MESH, TYPE R, CLASS 2, ECONOMY, DUAL SIZE / SINGLE SIZE



**8246Z/8246Z-S**  
VEST, TWO-TONE, MESH, TYPE R, CLASS 2, ZIPPER, REFLECTIVE BINDING, DUAL SIZE / SINGLE SIZE



**8249Z/8249-S**  
VEST, SURVEYORS, TYPE R, CLASS 2, ZIPPER, ECONOMY, DUAL SIZE / SINGLE SIZE



SIZE S/M  
INTERIOR ELASTIC CINCH CORD FOR CUSTOM FIT

**8210Z-BK**  
VEST, MESH, TYPE R, CLASS 2, ZIPPER, BLACK BOTTOM



INTERIOR ELASTIC CINCH CORD FOR CUSTOM FIT

**8251HDZ-BK**  
VEST, TWO-TONE, TYPE R, CLASS 2, MESH FRONT, SOLID BACK, ZIPPER, BLACK BOTTOM

SINGLE SIZE

EXTRA LENGTH, MORE TAILORED FIT

DUAL SIZE

LOOSER FIT, GOOD FOR WEAR WITH JACKETS



**MORE SIZING OPTIONS FOR A JUST-RIGHT FIT**

Word on the worksite was that hi-vis vest sizing was... inexact. Smalls were too large, larges were too small, cats and dogs living together, mass hysteria!

Well, by adding single size options to the mix, we've answered your call to accommodate those that were swimming in or squeezed by our traditional dual size options. Not too small, not too big... but juuust right. Call it the Glo-dilocks zone.

## PICK YOUR FIT CHOOSE SINGLE OR DUAL SIZING

\*SINGLE SIZE has extra length and a more tailored fit  
DUAL SIZE is a looser/wider fit, good for wear with jackets

\*Look for "-S" on the model number to know if a single size option is available

GLOWEAR® HI-VIS:

# CLASS 3 SAFETY VESTS

Our ANSI/ISEA 107 Class 3 Series is the north star of our high-visibility line. Brighter than a champagne supernova, these safety vests combine 360° of ANSI/ISEA 107-compliant visibility with heavy-duty construction, lightweight breathable fabrics and convenient pockets. When you need maximum visibility, this is the series for you.



**8310HL**  
VEST, ECONOMY, TYPE R,  
CLASS 3, HOOK & LOOP



**8315BA**  
VEST, BREAKAWAY, MESH, TYPE R,  
CLASS 3, HOOK & LOOP



**8320Z**  
VEST, STANDARD, TYPE R,  
CLASS 3, ZIPPER



**8330Z**  
VEST, TWO-TONE, TYPE R,  
CLASS 3, ZIPPER



**8346Z**  
VEST, TWO-TONE, TYPE R,  
CLASS 3, ZIPPER

## CUSTOM LOGO PROGRAM

### Mmm...SMELLS LIKE TEAM SPIRIT



#### HERE'S THE DRILL: CUSTOM LOGO PROGRAM

Our products come with designated logo locations, giving you flexible options to customize while maintaining a consistent look.

#### YOU GIVE US:

- Suitable digital art files or camera-ready artwork (EPS-format files work best but large, hi-res TIF or JPG files [3000 dpi] work too)
- All necessary PMS/Pantone colors
- Approval of a digital mock-up

#### WE GIVE YOU:

A product with a look all your own. Minimums vary based on the type of product. Don't worry, it's low.

Call Ergodyne Customer Support or your Sales Rep today to answer all your custom logo questions... we'll make it easy for you to look good!



BACK - 8205HL



FRONT - 8205HL

GLOWEAR® HI-VIS:

# FR CLASS 2 & CLASS 3 SAFETY VESTS

If it ain't one hazard, it's the mother truckin' other. Just as soon as you stave off struck-by accidents with GloWear's eye-popping ANSI/ISEA 107-compliant hi visibility and reflective material, sparks fly. Enter GloWear FR Class 2 and Class 3 Hi-Vis Vests. ASTM F1506-certified to squelch the danger and ensure your day doesn't go up in flames.

**FALL HARNESS COMPATIBLE**  
BACK/SIDE D-RING SLOT



**BREATHABLE**  
WESTEX® DH MATERIAL

**POCKETS**  
20  
INNER OUTER

**FR RADIO MIC TAB**

**ANSI/ISEA 107**

**8261FRHL**  
VEST, DUAL FR COMPLIANCE, CLASS 2, NFPA 2112, NFPA 70E, SOLID, HOOK & LOOP

**DUAL COMPLIANT**

**FR** NFPA 70E CAT 1  
NFPA 2112  
ATPV 6.6 CAL/CM²

## ONE LESS VEST TO SPEC

Why buy two vests when one will do? The GloWear 8261FRHL Vest offers dual FR compliance against flash fire and arc flash hazards, making ordering and replacing a breeze.



8261FRHL



### 8263FRHL

VEST, FR, TYPE R, CLASS 2, NFPA 70E, MESH, HOOK & LOOP, ECONOMY



### 8260FRHL

VEST, FR, TYPE R, CLASS 2, NFPA 70E, MESH, HOOK & LOOP



### 8262FRZ

VEST, FR, TYPE R, CLASS 2, NFPA 70E, SOLID FRONT, MESH BACK, ZIPPER, SURVEYOR



### 8356FRHL

VEST, FR, TYPE R, CLASS 3, NFPA 70E, MESH, HOOK & LOOP



**DUAL COMPLIANCE**  
NFPA 70E AND NFPA 2112  
FR STANDARDS

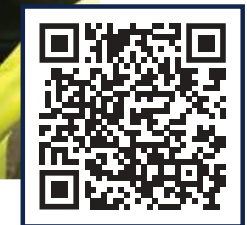

UNDERSTANDING  
DUAL COMPLIANCE  
FR STANDARDS

GLOWEAR® HI-VIS:

# PUBLIC SAFETY VESTS

You're protecting and serving and, for that, we thank you. Let us help you stay safe and visible while you're doing it. Our GloWear Public Safety Vests are designed for public service pros like you. With features like radio tabs, 5-point breakaway and a custom logo program to make sure the streets know who you are—we've got you covered in the line of duty.

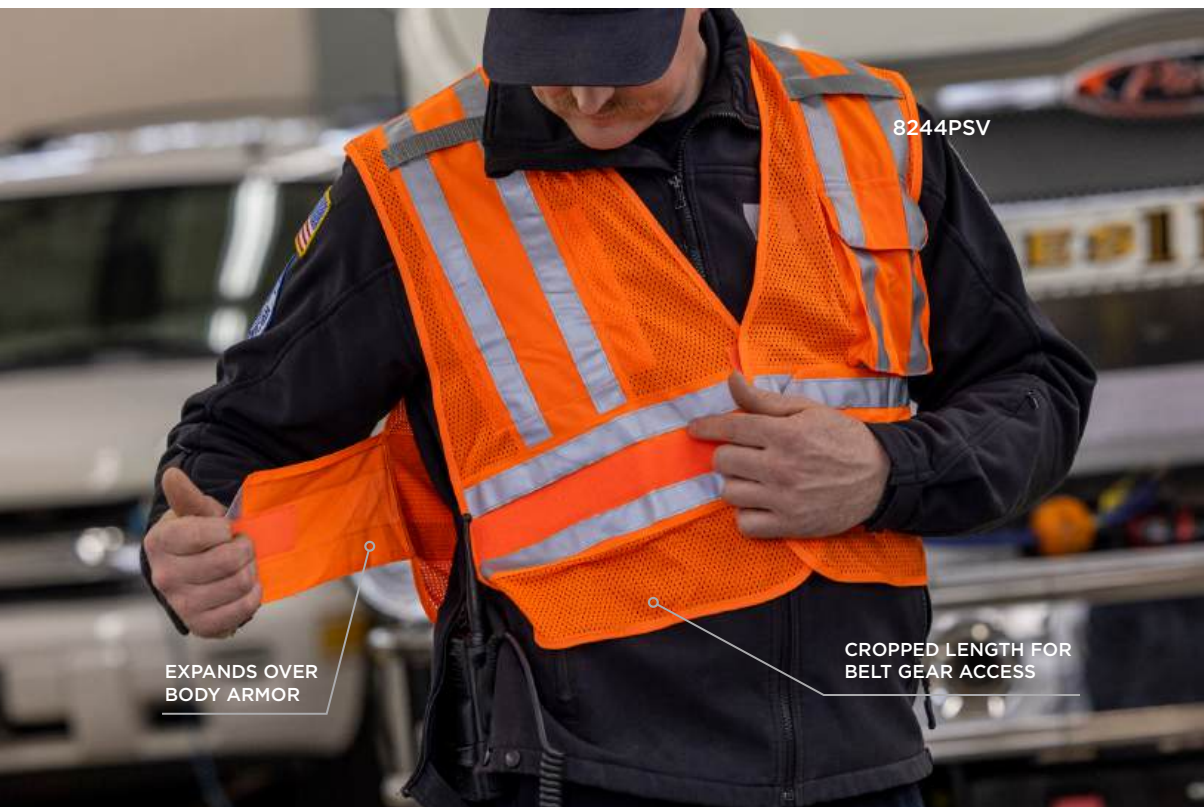

**8244PSV**  
VEST, EXPANDABLE, TYPE P,  
CLASS 2



8245PSV



**8245PSV**  
VEST, TWO-TONE,  
BREAKAWAY, TYPE P,  
CLASS 2

## SOMETIMES COMING UP SHORT IS A GOOD THING

Our public safety vests are designed with a shorter length for full and unobstructed access to your belt.

Plus, the added safety measure of hook & loop breakaway points at the shoulders and waist prevent dangerous hang ups.

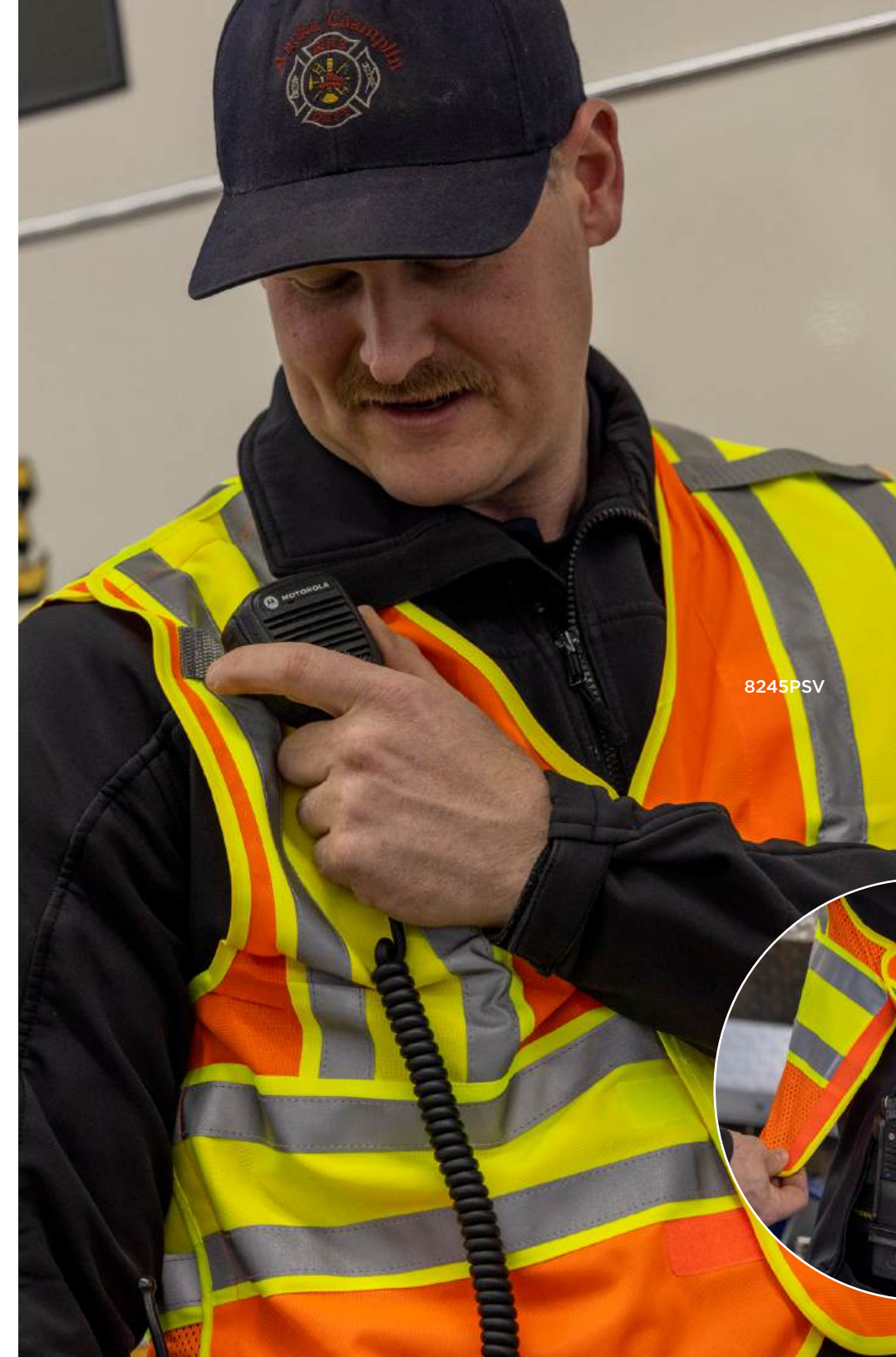
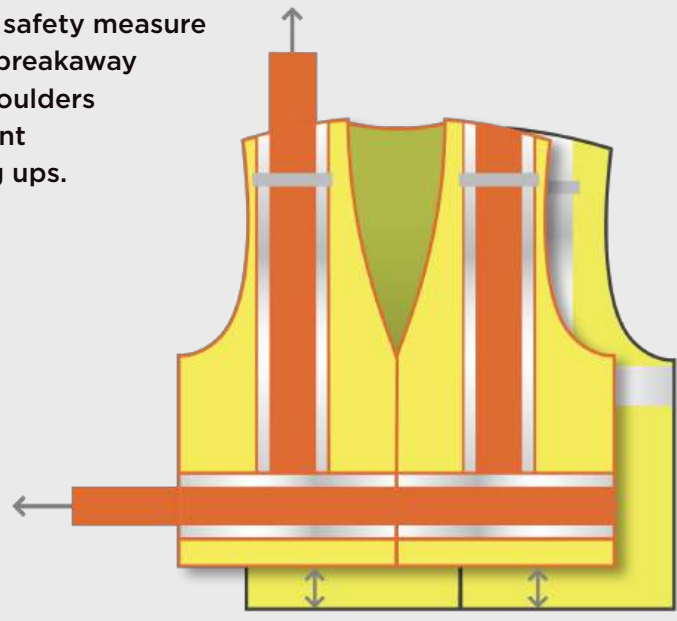

GLOWEAR® HI-VIS:

# CLASS 1 & NON-CERT SAFETY VESTS

Even if you don't have heavy construction hanging over your head or a hard hat job that requires it, GloWear's got your be-seen back. Sure, some of these safety vests are officially labeled non-compliant, but we guarantee they'll reflect well on your innate sense to avoid catastrophe and put safety first. From far-out fabrics and the latest reflective technology to 5-point breakaway and hook & loop closures—nobody brings brighter ideas to visibility than GloWear.



**8045X**  
VEST, NON-CERTIFIED,  
G-HOOK CLOSURE

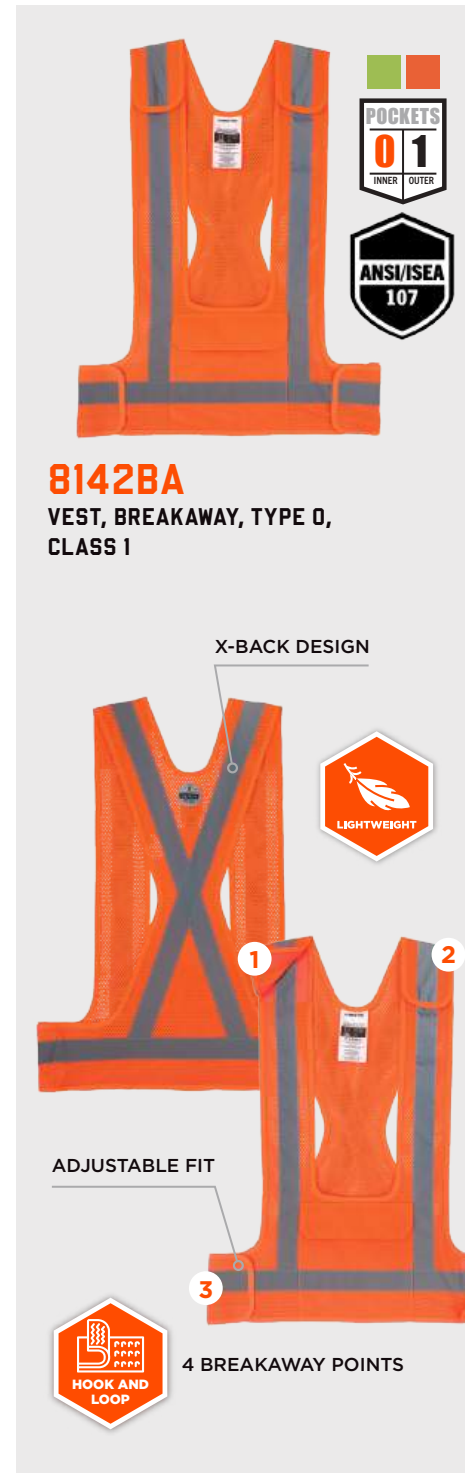

**8142BA**  
VEST, BREAKAWAY, TYPE O,  
CLASS 1

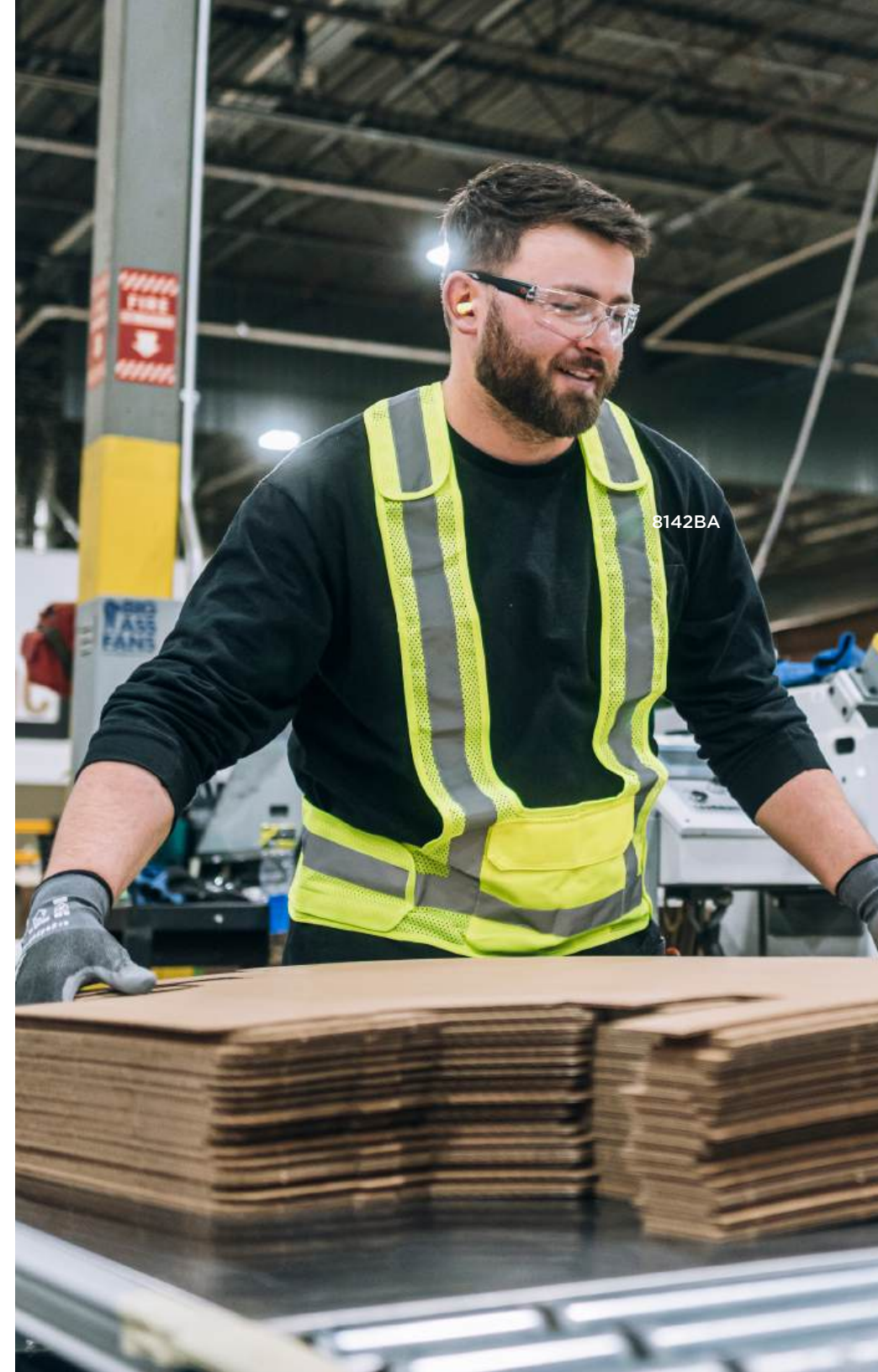

**8020HL**  
VEST, NON-CERTIFIED,  
HOOK & LOOP, STANDARD



**8040HL**  
VEST, COMBINED PERFORMANCE TAPE,  
NON-CERTIFIED, HOOK & LOOP



**8010HL**  
VEST, NON-CERTIFIED,  
HOOK & LOOP, ECONOMY



**8080BAX**  
VEST, X-BACK, NON-CERTIFIED,  
HOOK & LOOP



**8140BA**  
SASH, BREAKAWAY,  
TYPE O, CLASS 1



# HI-VIS COMPLIANCE ISN'T ROCKET SCIENCE

## WHICH IS TOO BAD, BECAUSE THAT'D PROBABLY BE EASIER

Fear not, we're here to break down the standard in simple(r) terms.



ANSI/ISEA 107 is the industry regulation that sets design requirements and performance testing criteria for all types and classes of high-visibility wear, particularly the amount of required fluorescent background material and reflective to keep workers safe and seen.



### PURPOSE



Enhances daytime visibility by adding contrast against background environments

### APPROVED FLUORESCENT COLORS



### PURPOSE



Enhances low-light nighttime visibility by reflecting light back toward the original source

### APPROVED REFLECTIVE



### PURPOSE



Creates biomotion that signals awareness to the brain that it is looking at a human

### REQUIREMENTS

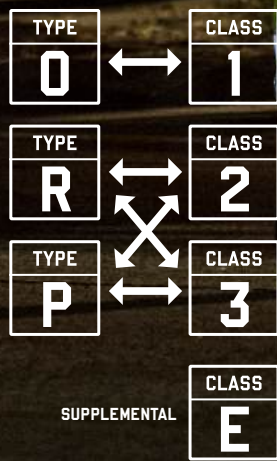

# ANSI/ISEA 107 HI-VIS PERFORMANCE CLASSES & TYPES

**DID YOU KNOW?**  
 The second digit of our GloWear vest model # dictates what class the item is

**82178A = Class 2**

CLASS	CLASS	CLASS	CLASS
1	2	3	E

### PERFORMANCE CLASSES

The standard breaks out three types of garments with five performance classes indicating how much of the garment has to be hi-vis material.

**CLASS 1**  
**WHAT IT IS**  
 Minimum hi-vis materials needed to differentiate wearer

**CLASS 2**  
**VISIBILITY**

**CLASS 3**  
**REQUIREMENTS**

- FLUORESCENT BACKGROUND 217 IN<sup>2</sup>
- REFLECTIVE 155 IN<sup>2</sup>
- REFLECTIVE WIDTH 1 IN<sup>2</sup>

**CLASS 1**  
**WHAT IT IS**  
 Additional hi-vis materials for better definition of the human form

**CLASS 2**  
**VISIBILITY**

**CLASS 3**  
**REQUIREMENTS**

- FLUORESCENT BACKGROUND 775 IN<sup>2</sup>
- REFLECTIVE 201 IN<sup>2</sup>
- REFLECTIVE WIDTH 1.28 IN<sup>2</sup>

**CLASS 1**  
**WHAT IT IS**  
 Most hi-vis materials for best definition in complex backgrounds

**CLASS 2**  
**VISIBILITY**

**CLASS 3**  
**REQUIREMENTS**

- FLUORESCENT BACKGROUND 1240 IN<sup>2</sup>
- REFLECTIVE 310 IN<sup>2</sup>
- REFLECTIVE WIDTH 2 IN<sup>2</sup>

**+** ADDITIONAL REQUIREMENTS: REFLECTIVE TAPE ON SLEEVES OR CLASS 2 TOP & CLASS E BOTTOMS

**CLASS 1**  
**WHAT IT IS**  
 Garments that do not classify when worn alone, but achieve Class 3 when worn with other Class 2 or Class 3 garment

**CLASS 2**  
**VISIBILITY**

**CLASS 3**  
**REQUIREMENTS**

- FLUORESCENT BACKGROUND 465 IN<sup>2</sup>
- REFLECTIVE 109 IN<sup>2</sup>
- REFLECTIVE WIDTH 2 IN<sup>2</sup>

TYPE	TYPE	TYPE
O	R	P

### TYPES

The standard breaks out the three types of garments into three types of worksite environments.

Type O = Off-Road // Type R = Roadway // Type P = Public Safety

**TYPE O**  
**WHEN IT'S USED**  
 For off-road, indoors or controlled environments, parking lots, festivals, extracting/refining oil & gas, warehouse/factories

**TYPE R**  
**APPLICATIONS**

**TYPE P**  
**COMPATIBLE WITH** CLASS 1

**TYPE O**  
**WHEN IT'S USED**  
 For environments with moving traffic or equipment traffic, minimum level of protection for workers exposed to roadway rights-of-way and temporary traffic control (TIC) zones

**TYPE R**  
**APPLICATIONS**

**TYPE P**  
**COMPATIBLE WITH** CLASS 2 CLASS 3

**TYPE O**  
**WHEN IT'S USED**  
 For environments with moving traffic or equipment traffic, emergency/incident response, police, fire, EMS only

**TYPE R**  
**APPLICATIONS**

**TYPE P**  
**COMPATIBLE WITH** CLASS 2 CLASS 3

GLOWEAR® HI-VIS:

# JACKETS

For workers who slug it out on Thunder Road in high-risk conditions, there's no better way to get year-round visibility and comfort than by wearing one of our 4-in-1 thermal or bomber safety jackets. The contagious, confident convergence of high-level visibility and versatility is designed to match wits with winter, spring or fall. With a weatherproof shell, toasty 3M™ Thinsulate™ insulation and reflective features galore, these jackets have enough firepower to make even the nastiest midnight run seem like a walk in the park.



**8275**  
WORKWEAR JACKET, TYPE R,  
CLASS 2, SHERPA LINED

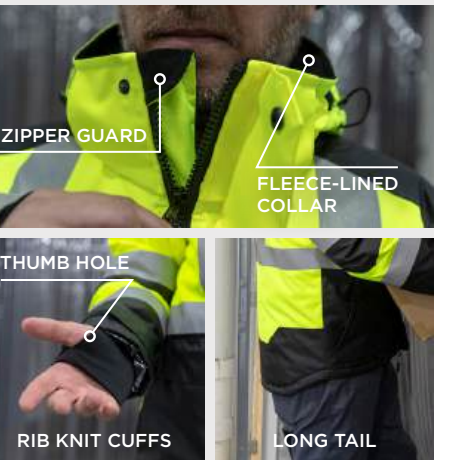

**8390**  
AMPLIFIRE™ JACKET, TYPE R,  
CLASS 3, HEAT REFLECTIVE LINING

- 300D POLYESTER WIND AND WATER RESISTANT PU COATING WITH FLEECE LINED COLLAR
- AmpliFIRE™ ALUMINUM INSULATION LINING CAPTURES, REFLECTS AND TRAPS BODY HEAT
- REMOVABLE HOOD, TWO-WAY ZIPPER, GUSSETED SLEEVES, RIB KNIT CUFFS WITH THUMB HOLES, D-RINGS AND DUAL MIC-TABS

RATED WARMEST  
**-55°F**  
(-48°C)



8390



## TEMP-RATED GEAR FOR WHATEVER YOU CALL COLD

**WARM**  
(above 0°F)

**8381**  
THERMAL 4-IN-1 JACKET,  
TYPE R, CLASS 3,  
QUILTED-SLEEVES BOMBER

**10°F**  
(-12°C)

**8379**  
THERMAL JACKET,  
TYPE R, CLASS 3,  
FLEECE-LINED BOMBER

**30°F**  
(-1°C)

**8351**  
WINDBREAKER WATER-  
RESISTANT JACKET,  
TYPE R, CLASS 3

**30°F**  
(-1°C)

**8353**  
SOFTSHELL WATER-  
RESISTANT JACKET,  
TYPE R, CLASS 3

**WARMER**  
(-19°F to 0°F)

**8385**  
4-IN-1 JACKET,  
TYPE R, CLASS 3

**WARMEST**  
(-20°F to -60°F)

**8287**  
THERMAL JACKET, TYPE R,  
CLASS 2, REMOVABLE SLEEVES

**-40°F**  
(-40°C)

**8377**  
THERMAL JACKET, TYPE R,  
CLASS 3, QUILTED BOMBER

**-30°F**  
(-34°C)

**8377EV**  
THERMAL JACKET, ENHANCED VISIBILITY,  
NON-CERTIFIED, QUILTED BOMBER

**-55°F**  
(-48°C)

**8384**  
THERMAL JACKET, TYPE R,  
CLASS 3, QUILTED PARKA

**-30°F**  
(-34°C)

**8388**  
THERMAL 4-IN-1 JACKET,  
TYPE R, CLASS 3/2

**-50°F**  
(-46°C)

**6478**  
AMPLIFIRE FREEZER JACKET, TYPE R,  
CLASS 2, HEAT REFLECTIVE LINING



GLOWEAR® HI-VIS:

# RAINWEAR

Rain, rain go away. Or don't. What do you care? After all, you're blazing brightly through the storm with ANSI/ISEA 107-compliant high visibility and weatherproof technology proven to shed rain of all varieties... Midnight, November, Purple or otherwise. With GloWear Hi-Vis Rainwear, rainy days may still get you down—but never for the count.



**8365**  
RAIN JACKET, TYPE R, CLASS 3,  
BREATHABLE



**8365BK**  
RAIN JACKET, TYPE R, CLASS 3,  
BLACK BOTTOM



# HI-VIS PANTS, BIBS & GAITERS

Shine like a dime in weatherproof perfection. With eye-catching reflective, Class 3 compliance (in combo with a Class 2 top), ANSI/ISEA 107-compliant background materials and wide legs for quick on/off convenience, these mesh-lined marvels breathe new life into hi-vis comfort.



**8366**  
RAIN JACKET, LIGHTWEIGHT,  
TYPE R, CLASS 3



**8376K**  
RAIN JACKET & PANT SUIT,  
LIGHTWEIGHT, TYPE R, CLASS 3



**8385**  
4-IN-1 RAIN JACKET,  
TYPE R, CLASS 3



**8386**  
RAIN JACKET, TYPE R, CLASS 3,  
OUTER SHELL



**8008**  
GAITERS, CLASS E



**8009**  
GAITERS, TWO-TONE MESH,  
CLASS E



**8910**  
PANTS, CLASS E



**8910BK**  
PANTS, BLACK BOTTOM, CLASS E



**8915**  
RAIN PANTS, CLASS E,  
BREATHABLE



**8915BK**  
RAIN PANTS, CLASS E,  
BLACK BOTTOM



**8916**  
RAIN PANTS, LIGHTWEIGHT,  
CLASS E



**8918BK**  
RAIN BIBS, CLASS E,  
BLACK BOTTOM



**8911**  
PANTS, TWO-TONE, CLASS E



**8925**  
PANTS, THERMAL, CLASS E



**6479**  
FREEZER BIB OVERALLS, CLASS E



**8928**  
BIBS, WEATHERPROOF,  
INSULATED, CLASS E

GLOWEAR® HI-VIS:

# HEADWEAR

Everything you need to knock heads with hard-charging hazards and hassles. From cooling sun hats to bonk-proof winter beanies, your melon stays covered, seen and ready for work through all the job's highs (blazing summer temps) and lows (clearance, light and a mercury line stuck somewhere south of reasonable).



**6802**  
CLASSIC TRAPPER HAT



**6803/ZI**  
REFLECTIVE RIB KNIT WINTER HAT WITH OR WITHOUT BUMP CAP



**8930**  
HAT, MESH VENTING PANELS



**8935/MF/CT**  
RANGER SUN HAT, MESH VENTING / MICROFIBER COOLING / PVA COOLING



**6650**  
HAT, HIGH-PERFORMANCE, COOLING



**8934**  
RANGER HAT WITH NECK SHADE

SOFT COMPRESSION FLEECE

TAKES 6.5 HOURS TO FULLY CHARGE

FOUR LIGHT MODES

UP TO 10.5 HOURS OF RUNTIME

**6801**  
WINTER SKULL CAP WITH LED RECHARGEABLE LIGHT



**6806**  
CUFFED RIB KNIT WINTER HAT



**6812**  
RIB KNIT WINTER HAT



**6821**  
BALACLAVA FACE MASK - FLEECE



**6823**  
BALACLAVA FACE MASK - WIND-PROOF, HINGED DESIGN



8935CT

GLOWEAR® HI-VIS:

# ACCESSORIES

Smart options to level-up the crew's conspicuity. Ha... *conspicuity*. That's fun to say. "Be seen" is another (less fun) way to say it. And whether driving, walking or just standing there, these add-ons help boost your conspicuity from every angle.



**8106**  
UNIVERSAL HI-VIS  
STRAP COVER



**8100**  
ARM AND LEG BAND,  
HOOK & LOOP



**6961**  
REFLECTIVE WINTER  
NECK GAITER



**6487R**  
MULTI-BAND, REFLECTIVE,  
COOLING



**8105**  
UNIVERSAL HI-VIS  
SEAT BELT COVER



**8005**  
NECK SHADE, MESH,  
REFLECTIVE



**8006**  
NECK SHADE, SOLID



**6670CT**  
NECK SHADE, EVAPORATIVE  
COOLING, PVA



**6661**  
UNIVERSAL HARD HAT BRIM  
WITH NECK SHADE



# HARD HAT ACCESSORIES

Hard hats work hard enough without turning into personal saunas. GloWear and Chill-Its liners, shades and sweatbands bring the temperature down while giving crews a clearer, brighter profile in low-light conditions. It's comfort, cooling and visibility—all built to integrate cleanly into standard suspensions so you can focus on the work, not the heat.





**PRINT'S NOT DEAD,  
IT'S JUST A LIL' PUTZY.**

CHECK OUT [ERGODYNE.COM](http://ERGODYNE.COM) FOR  
UP-TO-THE-NANOSECOND UPDATES ON  
OUR FULL LINE OF HI-VIS WORKWEAR



#### INTERGALACTIC HEADQUARTERS:

44° 58' 18.31" N 93° 09' 12.88" W ALT. 934 FT.  
1021 BANDANA BOULEVARD EAST  
SUITE 220 SAINT PAUL, MN, USA 55108

PHONE 651 642 9889 // 800 225 8238

ERGODYNE.COM

©2025 Tenacious Holdings Inc. All Rights Reserved. All Wrongs Reversed. Ergodyne, Ergoman and design, Ergodyne badge logo, E logo, Tenacious Work Gear, Be Tenacious, Arsenal, Chill-Its, DROP COPS, KREW'D, GloWear, N-Ferno, ProFlex, SHAX, Skullerz, Slips, Squids, Sticky Fingers and TREX are registered trademarks of Tenacious Holdings Incorporated and protected in the U.S. and abroad. AVC, Beverage Extrication Tool, Buddy System, CHILLX, Comfort Hinge, Drops Free Zone, DSX, Fog-Off, Hot Rox, Instrumentation Traps, Make the Workplace a Betterplace, Open-Center Stay, Orange Squad, Power Panel Positioner, Products for Occupational Athletes, QuickCuff, SOLARX, Squad Box, Storm Drains, Team Extreme, Team Tenacious, Tenacious Assault Vehicle, Tenacious Nation, Tenacious Talks, Tenacious Testers, Tenacious Toilet, Tenacious-U, Tena-Grip, Tena-Coat, Tenalux, THE NO BS SPF, Tool Tails, Tool Trap, Workday2Weekend and WSX are trademarks of Tenacious Holdings Incorporated. Trademarks of companies mentioned herein appear for identification purposes only and are the property of their respective companies. All other product names mentioned herein may be trademarks and/or registered trademarks of their respective owners Tenacious Holdings Inc. (dba Ergodyne) is a Klein Tools Company.

ergodyne®

**GLOWEAR® HI-VIS:  
BE SEEN. FEEL HEARD.**